

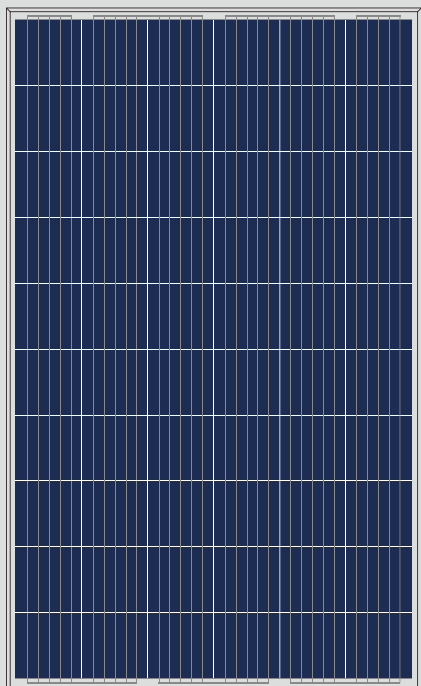

POLYCRYSTALLINE SILICON MODULE





Address: Floor 17-18th, No.4 Building Zhuyu International Commercial. Center, No.9 Shouti South Road, Haidian District, Beijing 100048, China
 Tel: +86-10-68796522
 Fax: +86-10-68796522
 E-mail: sales@cnbmsolar.com
 Website: www.cnbmsolar.com

**6P-260 6P-265 6P-270
 6P-275 6P-280
 POLYCRYSTALLINE SILICON MODULE**

Products Characteristics

- 

Widely using of the most popular and mature type of modules for on-grid system.
- 

Leading manufacturing technology in PV industry, strictly controlling the quality of raw materials and the process of producing
- 

100% EL inspection, ensures modules are defects free.
- 

Cells binned by current to improve module performance
- 

Anti reflective glass. Not only to increase the light absorption, but also to make the module has the function of self-cleaning in water environment, effectively reducing the power loss caused by dust.
- 

Outstanding performance in low-light irradiance environments.
- 

Excellent mechanical load resistance: Certified to withstand high wind loads(2400pa) and snow loads(5400pa).
- 

High salt and ammonia resistance
- 

Positive power tolerance: 0~+5w

Warranty

- 10 year product warranty
- 10 year 90% of Min. rated output power, and 25 year 80% of Min. rated output power warranty

Comprehensive Certificates

- ISO Certificate
- IEC61215、IEC61730 Certificate
- SGS-TUV Certificate
- CE Certificate

Specifications subject to technology and test conditions,

6P-260 6P-265 6P-270 6P-275 6P-280

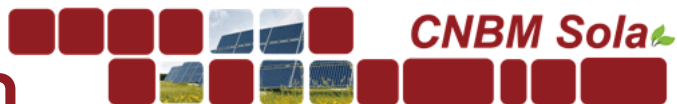

▼ Engineering Drawings (Front Side)

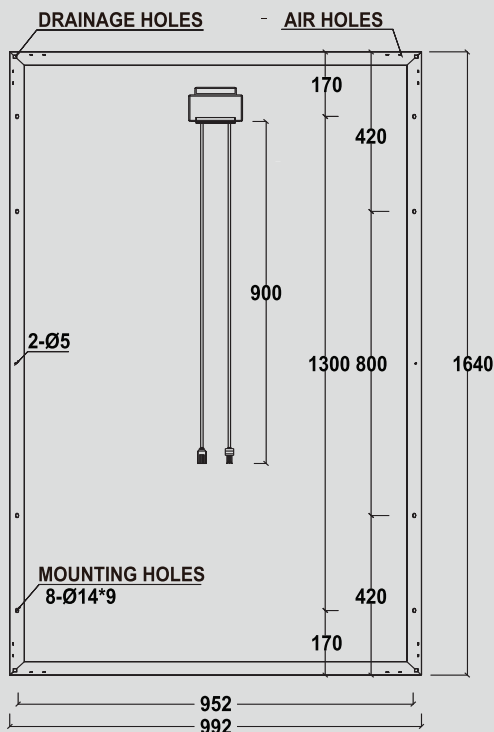
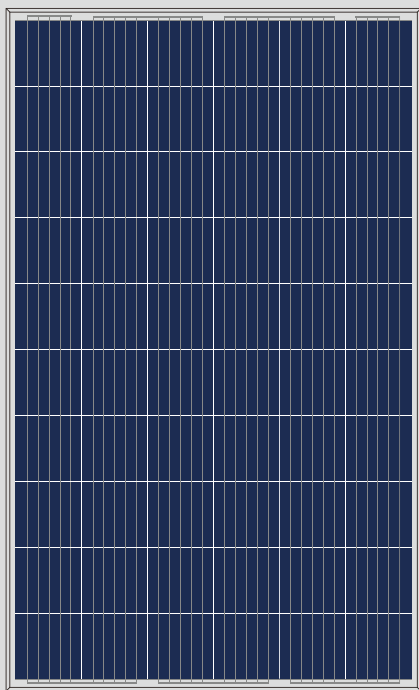

Address: Floor 17-18th, No.4 Building Zhuyu International Commercial. Center, No.9 Shouti South Road, Haidian District, Beijing 100048, China
 Tel: +86-10-68796522
 Fax: +86-10-68796522
 E-mail: sales@cnbmsolar.com
 Website: www.cnbmsolar.com

Raw Materials and Mechanical Parameters

	6P-260	6P-265	6P-270	6P-275	6P-280
Type of Cells(mm)	poly156.75 × 156.75				
NO. of Cells and Connections	6 × 10=60				
Dimensions(mm)(L*W*H)	1640 × 992 × 35/40				
Weight(kg)	17.9/18.2				
Glass	3.2mm Tempered Glass				
Encapsulation	EVA				
Backsheet	Multilayer Composite				
Aluminium-Frame	Silvery/Black Anodized aluminium alloy				
Junction-Box	IP67/IP68				
Cable	4mm ² , 900mm				
Connector	MC4 and MC4 Compatible				
Package Configuration	30/26 pcs/pallet				
40GP	840pcs (30/PALLET)		728pcs (26/PALLET)		
40HQ	896pcs (30/PALLET)		784pcs (26/PALLET)		

Performance Parameters

	6P-260	6P-265	6P-270	6P-275	6P-280
Maximum System Voltage	1000V				
Operating Temperature	-45~+80℃				
Maximum Series Fuse	20A				
Maximum Static Load, Front Side (e.x. Snow, Wind)	5400PA				
Maximum Static Load, Back Side (e.x. Wind)	2400PA				
Application Grade	Class A				

Electrical Parameters (Standard Test Condition)

	6P-260	6P-265	6P-270	6P-275	6P-280
Rated Maximum Power(Mp)	260W	265W	270W	275W	280W
Power Tolerance	0- +5W				
Module Efficiency	15.98%	16.29%	16.60%	16.90%	17.21%
Open Circuit Voltage(Voc)	37.9V	38.1V	38.3V	38.6V	38.8V
Maximum Power Voltage(Vmp)	30.7V	30.9V	31.1V	31.3V	31.5V
Short Circuit Current(Isc)	8.98A	9.09A	9.20A	9.31A	9.42A
Maximum Power Current(Imp)	8.47A	8.58A	8.68A	8.79A	8.89A
Temperature Coefficient of Isc	+0.06%				
Temperature Coefficient of Voc	-0.33%				
Temperature Coefficient of Pmp	-0.45%				
Standard Test Condition	Irradiance:1000W/M2, Cell Temperature:25℃, Spectrum AM:1.5				

The Electrical Parameters of the module are the average theory figure under the standard test condition, each one exists difference. Can not be treated as the basis of module delivery.